

# photomultiplier HV Base

## HV51K20CN series data sheet

### 1 description

The HV51K20CN is a compact photomultiplier negative polarity HV Base operating from a low voltage supply (+5 to +15 V). It incorporates a CW multiplier that directly supplies voltages to the photomultiplier electrodes. The HV Base is intended for use with 10-stage, 51 mm diameter capped photomultipliers for applications requiring up to -2000 volts and ac or dc coupling.

The unit is housed in a screened cylindrical metal enclosure, the diameter of which is compatible with the photomultiplier overcap. Threaded mounting bushes are provided. The anode output is via a 0.5 m length of shielded RG174U cable.

The photomultiplier operating voltage is set using any one of three programming options as shown in section 8. The anode may be operated at ground potential in the HV51K20CN.

### 2 applications

The HV51K20CN is designed for use in the following photomultiplier operating modes:

- current measurement (analogue)
- pulsed light
- photon counting

### 3 features

- low power consumption
- compact
- no high voltage cables
- low noise
- linearity limited only by photomultiplier performance

### 4 specifications

| at HV = -1000V                                                     | unit    | min  | typ | max   |
|--------------------------------------------------------------------|---------|------|-----|-------|
| <b>supply voltage</b>                                              | V       | +5   |     | +15   |
| <b>control voltage</b>                                             | V       | +0.1 |     | +2    |
| <b>output high voltage</b>                                         | V       | -100 |     | -2000 |
| <b>output (anode) current</b>                                      | $\mu$ A |      |     | 200*  |
| <b>supply current at +5 V;</b><br>for anode current = 0 $\mu$ A    | mA      |      | 1.5 |       |
| for anode current = 100 $\mu$ A                                    | mA      |      | 6.5 |       |
| <b>supply current at +12 V:</b><br>for anode current = 0 $\mu$ A   | mA      |      | 1   |       |
| for anode current = 100 $\mu$ A                                    | mA      |      | 5   |       |
| <b>line regulation</b>                                             | %/V     |      |     | 0.01  |
| <b>anode load regulation:</b><br>for anode current 0 - 100 $\mu$ A |         |      |     | 0.01  |
| <b>temperature coefficient</b>                                     | %/°C    |      |     | 0.02  |
| <b>switch-on time</b> (10 - 90%)                                   | s       |      | 0.2 |       |
| <b>switch-off time</b> (90 - 10%)<br>no pmt                        | s       |      | 30  |       |
| <b>anode ripple:</b><br>with 10 k $\Omega$   20 pF load            | mV(p-p) |      | 1   |       |
| <b>weight</b>                                                      | g       |      | 87  |       |

\*subject to photomultiplier limit

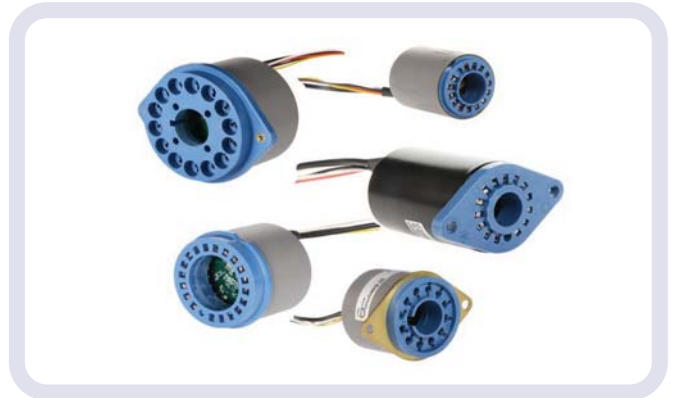

### 5 ratings

|                                                              | unit | min | typ | max |
|--------------------------------------------------------------|------|-----|-----|-----|
| <b>supply voltage</b>                                        | V    | 4.5 |     | 18  |
| <b>control voltage</b>                                       | V    | 0   |     | 3   |
| <b>temperature (operating):</b><br>at 93% RH, non-condensing | °C   | -40 |     | 60  |

### 6 schematic diagram

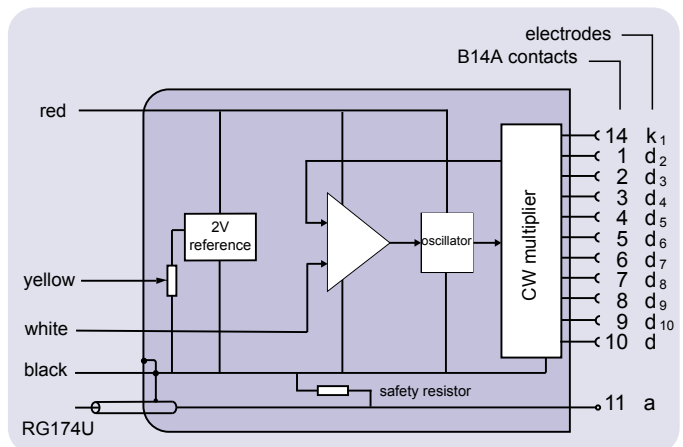

### 7 voltage distribution

The photomultiplier pin configuration for this HV Base is given below. The voltage distribution for an applied HV of V volts is shown in the table. Note that an anode load resistor is not included. A 10 M $\Omega$  safety resistor is connected between anode and ground to ensure that the output is kept at 0 V.

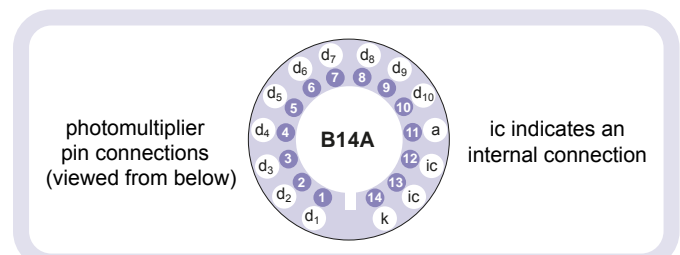

| k     | d <sub>1</sub> | d <sub>2</sub> | ..... | d <sub>9</sub> | d <sub>10</sub> | a |
|-------|----------------|----------------|-------|----------------|-----------------|---|
| 2/12V | 1/12V          | 1/12V          |       | 1/12V          | 1/12V           |   |

## 8 programming options

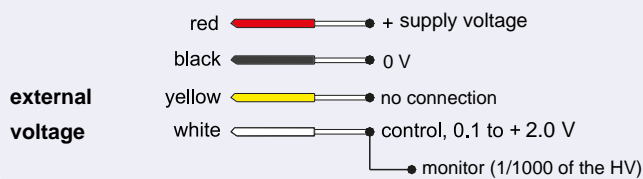
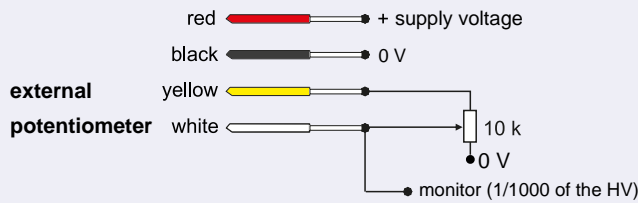
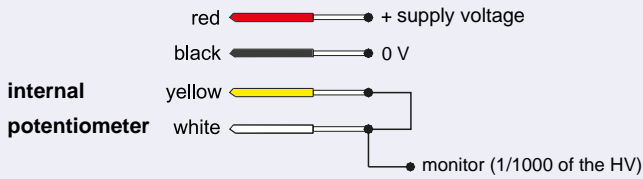

## 9 dimensions and photomultiplier options

The HV51K20CN series HV base can be used with the following photomultipliers:

9250KB, 9256KB, 9266KB

all dimensions in mm

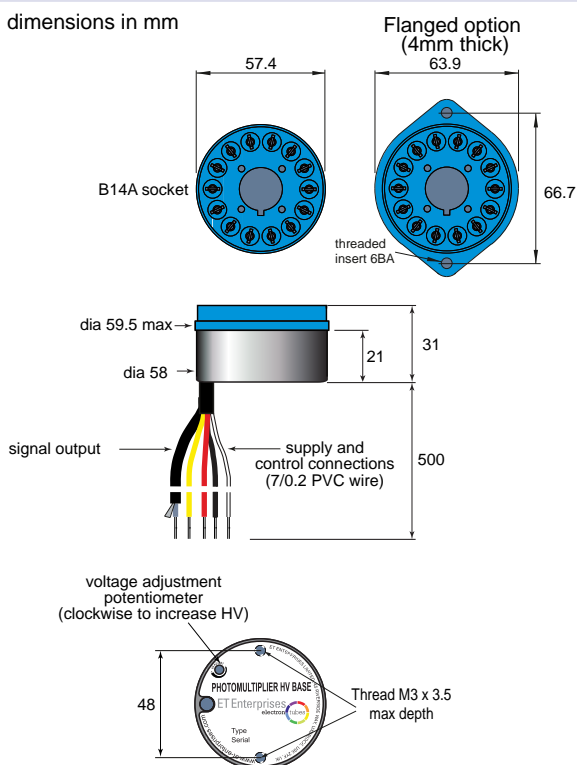

## 10 linearity

Linearity performance is dependent on the particular photomultiplier being used with the HV Base. It is measured as the % deviation in either peak pulse current, or average current, depending on the mode of operation.

Please refer to the corresponding photomultiplier data sheet for further information.

## 11 output configurations

The pmt anode in the HV51K20CN HV Base is internally grounded via a 10 M $\Omega$  safety resistor. Depending on the mode of operation, the output circuitry should be configured externally as shown in the example configurations below. For dc and scintillation applications  $R_L$  is typically 100 K $\Omega$ , but for fast pulse applications  $R_L$  would normally be 50  $\Omega$ . In the latter case an internal 50  $\Omega$  matching resistor can be fitted (to special order).

a) dc current output

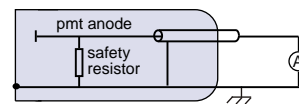

b) dc voltage output

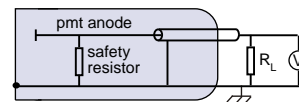

c) ac coupled output

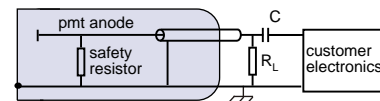

C = external coupling capacitor  
 $R_L$  = external load resistor

## 12 ordering information

| item           | ordering code |
|----------------|---------------|
| without flange | HV51K20CN     |
| with flange    | HV51K20CNF    |

## 13 warning

High voltages generated by these products present an electrical shock hazard and appropriate precautions must be taken.

Installation must be by qualified personnel.

All units are despatched with the internal potentiometer set to zero.

Do not operate outside the quoted ratings of the HV51K20CN or those of the photomultiplier. This may result in loss of performance, permanent damage, or both.